



# Vertical Mount Shelf Lighting

**Phantom™ Classic VM Series** light strips provide the ultimate performance and flexibility as a seamless, concealed low voltage linear lighting source. All Phantom VM Series lighting strips are manufactured to your exact specifications using a variety of custom metal glare shields, so that the light is always perfectly controlled while keeping the fixture out of sight. Lamping options include 3 watt, 5 watt, and 10 watt Xenon festoon lamps (rated for up to 20,000 hours) and LED lamps (rated for up to 40,000 hours). Energy-efficient 0.6 watt 12VAC LED lamps are ideal for applications where energy code compliance is an issue or a major consideration.

All lamping options are fully dimmable for achieving the perfect light level or to extend lamp life. Phantom VM series light strips are available unfinished or in eight painted colors. Please contact the factory if you're interested in our custom color options. Phantom Lighting is all about seeing the light, not the fixture.

## PHANTOM CLASSIC VM SERIES FEATURES

- Low profile, concealed linear lighting source designed for adjustable shelf lighting or adjustable display applications
- Paint grip galvanized metal trim with unique glare shields specifically designed for vertical shelves or display lighting applications
- Customizable wiring methods designed for any application
- Multiple trim shapes available for custom applications or for use above eye-level
- LED and Xenon festoon lamping options
- ETL Listed, Miscellaneous fixtures, conforms to UL STD, 1598

## Classic VM Series Exploded View

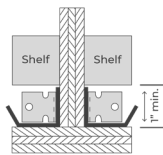

### DUAL FIXTURES

The Phantom fixture can be attached behind both vertical stiles, sending light in each direction.

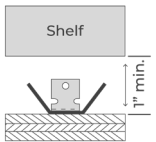

### CENTER MOUNT

The Phantom fixture can be attached to the center vertical stile or door trim, using trim #5 to send light in both directions.

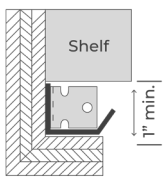

### SPACE REQUIREMENT

On a cabinet with adjustable shelves, 1" of clearance is required between the back surface of the stile and the front of the shelf. This will provide the space to move shelves without modifying the Phantom fixture.

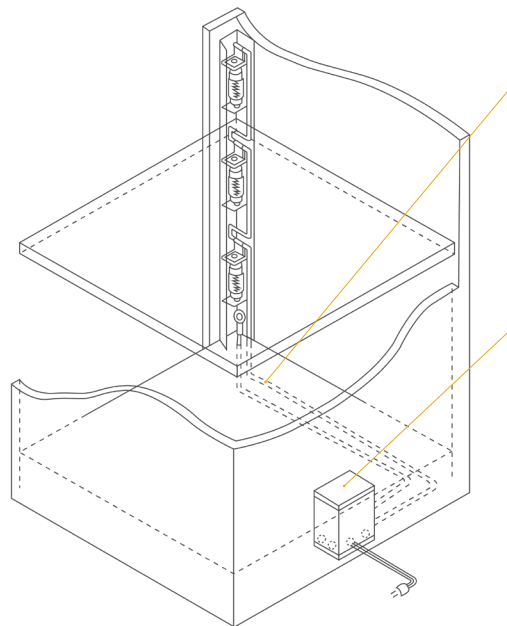

### CONCEALED WIRING

For fixed shelving, furniture or retrofit applications, it may be necessary to conceal the wiring from individual fixtures back to the transformer. We are happy to manufacture your lighting strips with long leads to accommodate any application. Consult factory for other fixed wiring methods.

### TRANSFORMER

Magnetic transformers are sized to match the total wattage of your lighting load and come equipped with one or more secondary circuit breakers. (See driver sheet for more sizing information and amperage calculations).

### DIMMER CONTROLS (BY OTHERS)

Magnetic low voltage transformers should always be used with a dimmer designated for magnetic or inductive loads. Electronic transformers should always be used with a dimmer designated for electronic loads.

# Classic VM Series Trim Profiles

Choose your trim profile based on your mounting application and the level of glare desired.

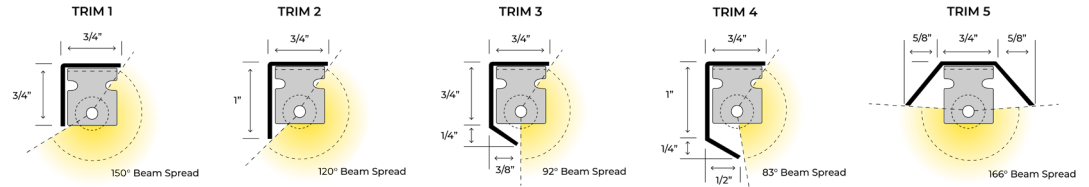

# Classic VM Series Lamps

Xenon festoon lamps are available in 3 watt, 5 watt, and 10 watt, in both 12VAC and 24VAC. Xenon lamps (2,800°K) typically produce a whiter light and are used for display lighting. Average life for a Xenon festoon lamp is 20,000 hours. LED festoon lamps are available in a 0.6 watt, 12VAC or 24 VAC models in several popular color temperatures. LED festoon lamps produce very little forward throw heat, no UV rays, and have an average lamp life of 40,000 hours. LED festoon lamps are perfect for retrofit applications or new projects that require a bright, efficient light source in hard to reach areas.

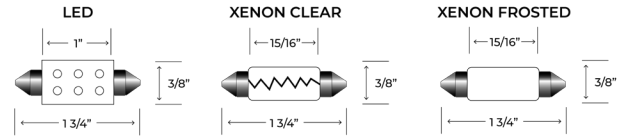

### LED Kelvin Colors

- 2700 K
- 3500 K
- 5000 K

### Xenon Kelvin Colors

- 2800K Clear
- 2800K Frost

# Classic VM Series Transformers

## TRANSFORMER SPECIFICATIONS

	20W	40W	60W	100W	150W	250W	500W
<b>120/12VAC</b>	MT20-12	MT40-12	MT60-12	MT100-12	MT150-12	MT250-12	MT500-12
<b>120/24VAC</b>	MT20-24	MT40-24	MT60-24	MT100-24	MT150-24	MT250-24	MT500-24
<b>Max Wattage*</b>	16	32	48	80	120	200	400
<b>12V Breaker</b>	Auto Reset	Auto Reset	Auto Reset	Auto Reset	Auto Reset	(1) 25A Push	(2) 25A Push
<b>24V Breaker</b>	Auto Reset	Auto Reset	Auto Reset	Auto Reset	Auto Reset	(1) 10A Push	(1) 25A Push
<b>Height (H)</b>	5.60"	5.60"	6.55"	6.55"	9.80"	6.75"	8.25"
<b>Width (W)</b>	2.10"	2.10"	2.55"	2.55"	3.00"	4.875"	5.62"
<b>Depth (D)</b>	2.10"	2.10"	2.55"	2.55"	3.00"	4.62"	5.25"
<b>Weight (lbs)</b>	2	2	3	7	7	13	19

\*These numbers reflect the 20% safety factor that is recommended to avoid overload or nuisance tripping when selecting a transformer. (Wattage x 1.20)

To calculate amperage, divide total wattage by secondary voltage (Wattage/Voltage = Amperage).  
To calculate wattage, divide amperage by secondary voltage (Amperage/Voltage = Wattage)

Phantom Classic Lighting Strips - Ordering Matrix  
Sample Order Number: **VM-1-4-0.6-12-27-DL-12-FW-24**

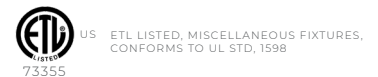

MODEL	TRIM PROFILE	LAMP SPACING	LAMP WATTAGE	OPERATING VOLTAGE	LAMP TYPE	LEAD TYPE*	LEAD LENGTH	TRIM COLOR	TRIM LENGTH
<b>VM</b>	<b>1</b>	<b>4</b>	<b>0.6</b>	<b>12</b>	<b>27</b>	<b>DL</b>	<b>12"</b>	<b>FW</b>	<b>24"</b>
VM	1	4"	0.6 - LED	12	27 - 2700K LED	DL - Double Leads	12"	FW - Flat White	Inches
	2	6"		24	35 - 3500K LED			GW - Gloss White	
	3	CS -	3 - Xenon		50 - 5000K LED			FB - Flat Black	Specify
	4	Custom Spacing	5 - Xenon		XFR - Frost Xenon	TR - Top Right		GB - Gloss Black	Your Trim
	5		10 - Xenon		XCL - Clear Xenon	TL - Top Left		LB - Light Beige	Length In
						BL - Bottom Left		MB - Medium Brown	Inches
						BR - Bottom Right		LA - Light Almond	
								UF - Unfinished	
								CC - Custom Color**	

\*When facing application  
\*\*Contact factory for details