

INSTALLATION INSTRUCTIONS (1/2)

READ AND UNDERSTAND THESE INSTRUCTIONS BEFORE INSTALLATION – SAVE THESE INSTRUCTIONS!

These fixtures are intended for installation in accordance with the National Electrical Code and local regulations. To ensure full compliance with local codes and regulations, check with your local electrical inspector before installation. To prevent electrical shock, turn off electricity at fuse box before proceeding. Remove all components from the shipping carton. The instructions are in a step by step sequence for correct and easy assembly. Save the shipping carton and packing materials until job is complete.

IMPORTANT: THE ELITE AC SERIES IS INTENDED ONLY FOR NEW CONSTRUCTION OF BUILT-IN CABINETRY.
For installation on existing built-in cabinetry or other applications, please look into our other strip lighting options.

REQUIRED COMPONENTS

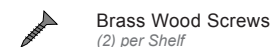
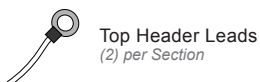
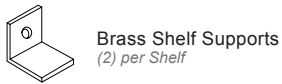
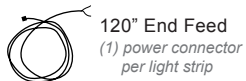
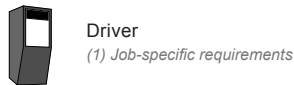
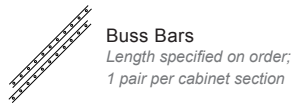

1. CALCULATE DRIVER REQUIREMENTS

Available driver sizes: 20W, 40W, 60W, 96W, 150W, 200W, 300W

Elite lighting strips **without a lens** use standard LED tapes, producing either 1.8 or 2.2 watts per foot. Example: a cabinet containing 10' of 1.8W Elite Lighting Strips, 10' x 1.8 watts/ft = 18 total watts. Always allow a 20% safety factor when sizing to prevent nuisance tripping. Example: 18 watts x 1.2 = 21.6 watts, requiring a 40-watt driver. **Maximum run length per 1.8W feed is 50 feet or 90 watts; maximum run length per 2.2W feed is 45 feet or 99 watts.**

Elite lighting strips **with a lens** use high-density LED tapes, producing either 1.5 or 2.8 watts per foot. Example: a cabinet containing 10' of 1.5W Elite Lighting Strips, 10' x 1.5 watts/ft = 15 total watts. Always allow 20% safety factor when sizing to prevent nuisance tripping. Example: 15 watts x 1.2 = 18 watts, requiring a 20-watt driver. **Maximum run length per 1.5W feed is 50 feet or 75 watts; maximum run length per 2.8W feed is 35 feet or 98 watts.**

2. DETERMINE LOCATION OF DRIVER

The driver should be out of sight, but still accessible for servicing if necessary. Some electricians install it in the attic above the display, while others conceal it in the base or header of the cabinet.

NOTE: the installer should use normal voltage drop calculations when determining the distance from the cabinet. Typically, the distance should not exceed 20' from location when using 16-gauge wire. If farther, use larger gauge wire.

3. INSTALL BUSS BARS WITH LUGS & TOP HEADER LEADS

First, the cabinet maker will route out the outer sides of the cabinet in order to accommodate the buss bars, which have dimensions of 5/8"W x 1/4"D. Each cabinet section will require a buss bar on either side. For multiple continuous cabinet sections, maintain adequate space between sections so that the buss bars from adjacent sections are not in contact with the neighboring buss bar or shelf support screws. Next, the driver will be connected to the buss bars with a lug, at either the top or bottom of the cabinet. Each lug must screw directly into a threaded hole into the buss bar, so an opening must be cut in the side wall of the base cabinet to expose the locations where lug connections are to be made. The **Top Header Leads**, small wires designed to transition from each buss bar to the fixed light strip at the top of the cabinet behind the reveal. Installer should drill small holes and stub out the wires on each side for final connection to the top header strip lights using either small wire nuts or crimp connectors.

Note: take care to match the polarity (hot and neutral) of the driver/buss bar connection with the polarity of the lighting strip fixtures. The fixture wires will be connected to the contact pads on either end of the fixture, hot on one end and neutral on the opposite end. All fixtures in a given cabinet section must maintain the same polarity, consistent with the polarity of the buss bars for that section.

4. MOUNTING THE LIGHT ON THE HEADER

Using lead wires from the Top Header kit, install the light strip in the top of the cabinet and terminate connections. Repeat this step on each cabinet section.

5. DETERMINE LOCATION OF ADJUSTABLE SHELVES

Once the location is decided, use a brass machine screw to attach the front shelf support clips through the sides of the cabinet into the threaded holes of the cabinet and buss bar. The brass screws assure completion of the circuit between the concealed metal components. If the shelf needs to be moved, set the location, then move the screw and front shelf clips to the desired location. **Note:** back offset shelf supports are not included.

INSTRUCTIONS CONTINUED ON REVERSE

INSTALLATION INSTRUCTIONS (2/2)

6. INSTALL PHANTOM ELITE LIGHTING STRIP

Noting the polarity of the buss bars, separate the two wires on the end connecting cable and run one of them to the opposite end of the shelf, making sure this wire matches the polarity of the corresponding buss bar. The lighting strip is mounted on the underside of each shelf. Position the wire that runs to the opposite end in the raceway behind the lighting strips. Trim both wires to the correct length and terminate each with the supplied ring connectors to be positioned under the contact pads. Contact pads are installed and aligned with the front shelf supports. When the adjustable shelf is set in place, the contact pads rest on the shelf supports, completing the circuit and allowing the strip to be powered and illuminated.

Note: beware of electrical shortage if contact pads touch any part of the metal trim.

7. CONNECT THE DRIVER

Using a dimmer is optional, but **not required** for this product. Low voltage dimmers are not included with this product; please visit our website for a list of compatible magnetic low-voltage dimmers or call technical support.

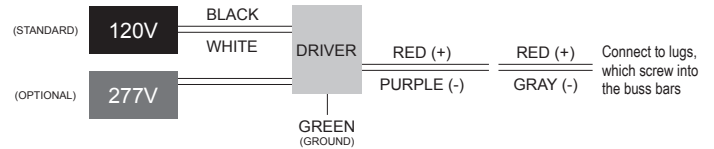

VISUAL INSTRUCTIONS AND ADDITIONAL INFORMATION

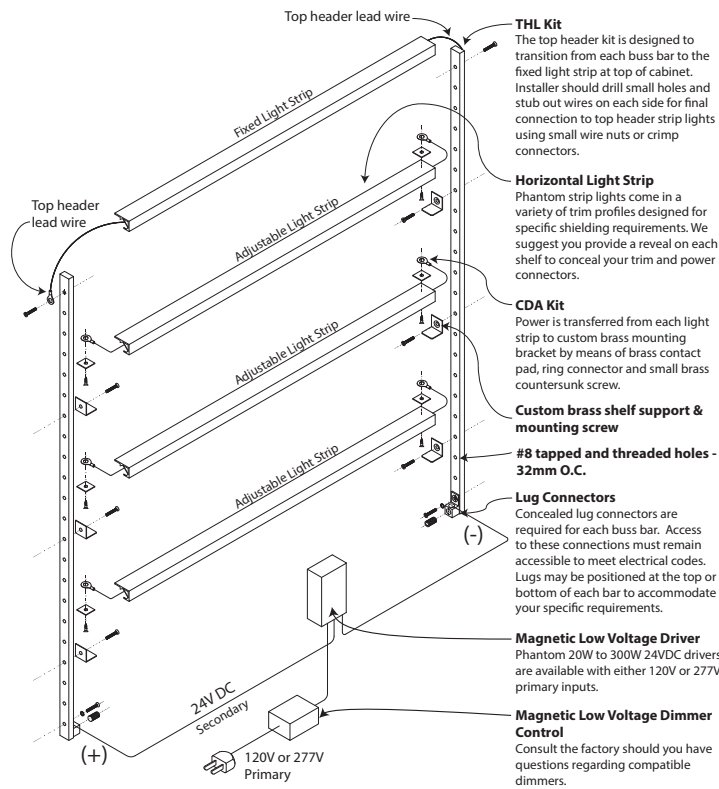

SIDE VIEW

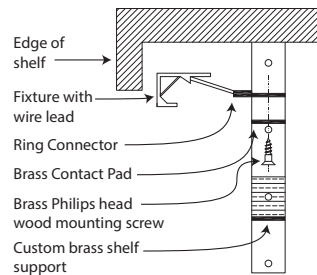

TOP VIEW

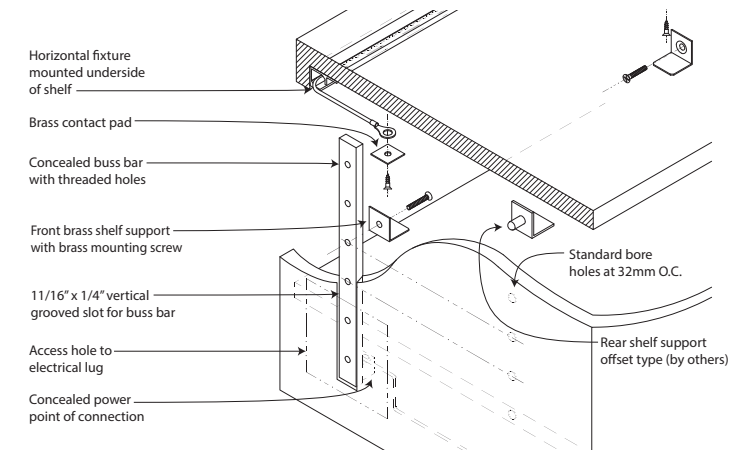
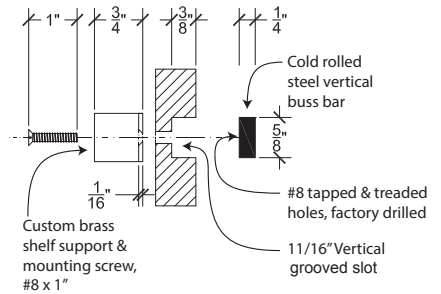

TERMS & CONDITIONS

To comply with Phantom Lighting System warranty policies and ETL Standards, all lighting strips must be used in conjunction with Phantom Lighting drivers. All Phantom Lighting drivers are ETL Approved and are strongly recommended for proper operation of lighting strips. Phantom Drivers should not be located in areas with no ventilation or subject to high ambient temperatures. If ambient temperature exceeds 115°F (46°C) around the driver, the circuit breakers may nuisance-trip due to excessive heat and void any warranty.

CAUTION: FAILURE TO CORRECTLY SIZE THE PRIMARY AND SECONDARY CONDUCTORS AND/OR THE OVERLOAD PROTECTION MAY RESULT IN BODILY INJURY AND/OR SERIOUS PROPERTY DAMAGE

If you have any questions or concerns regarding your application, please contact the Phantom factory at the number listed below, a local licensed electrician, or consult the U.S. National Electric Code.

