



CABINET LIGHTING

ADJUSTABLE
EXPOSED SERIES



CLASSIC LEVEL

Adjustable Exposed Shelf Lighting

Phantom™ Classic AE Series light strips provide the ultimate performance and flexibility as a seamless, concealed low voltage linear lighting source. All Phantom AE Series lighting strips are manufactured to your exact specifications using a variety of custom metal glare shields, so that the light is always perfectly controlled while keeping the fixture out of sight. Lamping options include 3 watt, 5 watt, and 10 watt Xenon festoon lamps (rated for up to 20,000 hours) and LED lamps. Energy-efficient 0.6 watt 12VAC LED lamps (rated for up to 40,000 hours) are ideal for applications where energy code compliance is an issue or a major consideration.

All lamping options are fully dimmable for achieving the perfect light level or to extend lamp life. Phantom AE series light strips are available unfinished or in eight painted colors. Please contact the factory if you're interested in our custom color options. Phantom Lighting is all about seeing the light, not the fixture.

PHANTOM CLASSIC AE SERIES FEATURES

- Low profile, concealed linear lighting source designed for adjustable shelf lighting or adjustable display applications
- Current carrying concealed custom shelf supports, with no unsightly exposed wiring or connectors
- Paint grip galvanized metal trim with unique glare shields specifically designed for horizontal shelves or display lighting applications
- Multiple trim shapes available for custom applications or for use above eye-level
- LED and Xenon festoon lamping options
- ETL Listed, Miscellaneous fixtures, conforms to UL STD, 1598

Classic AE Series Exploded View

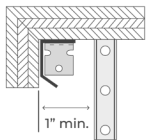

SPACE REQUIREMENT

For best results, a wood reveal should be used to conceal the fixture. For applications above eye level use trim #4 & extend wood trim as necessary. Allow 1" clearance between light fixture and holes.

LIGHTING STRIP

Each lighting strip may contain one or more festoon lamps with spacing 4 or 6 inches on center. For best results, always use a matte finish on the back of the cabinet to minimize reflections or glare.

POWER CONNECTION

Attach power leads from transformer to existing buss bar using ring connectors provided with product.

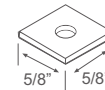
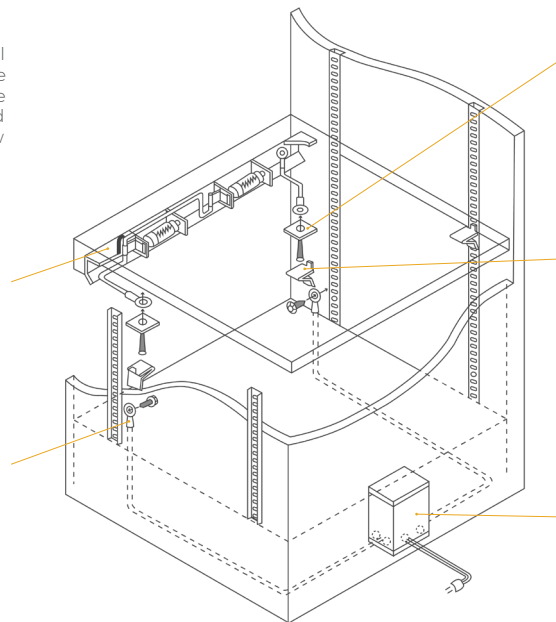

BRASS CONTACT PADS

Brass contact pads are designed to transfer electricity from the shelf support clip to the individual fixtures utilizing a safe low voltage current. Contact is made when the shelf is installed. No tools are required to rearrange the shelves!

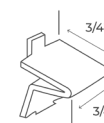

EXPOSED STEEL SHELF SUPPORTS (BY OTHERS)

You can easily energize new or existing steel supports to conduct safe low voltage current for our exposed wiring method. This system virtually eliminates all the visible wiring and allows you to use standard shelf support clips. The use of aluminum shelf supports is **not** recommended!

TRANSFORMERS

Magnetic transformers are sized to match the total wattage of your lighting load and come equipped with one or more secondary circuit breakers. (See driver sheet for more sizing information and amperage calculations).

Classic AE Series Trim Profiles

Phantom offers a variety of trim profiles to suit any lighting application. Choose your trim profile based on your mounting application and the level of glare desired.

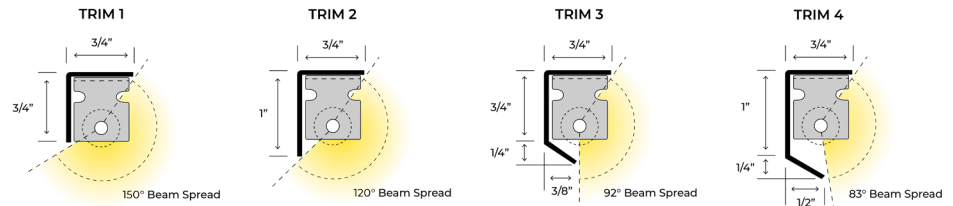

Classic AE Series Lamps

Xenon festoon lamps are available in 3 watt, 5 watt, and 10 watt, in both 12VAC and 24VAC. Xenon lamps (2,800°K) typically produce a whiter light and are used for display lighting. Average life for a Xenon festoon lamp is 20,000 hours. LED festoon lamps are available in a 0.6 watt, 12VAC or 24 VAC models in several popular color temperatures. LED festoon lamps produce very little forward throw heat, no UV rays, and have an average lamp life of 40,000 hours. LED festoon lamps are perfect for retrofit applications or new projects that require a bright, efficient light source in hard to reach areas.

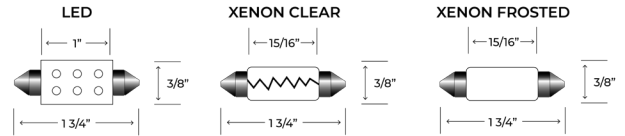

LED Kelvin Colors

2700 K 3500 K 5000 K

Xenon Kelvin Colors

2800K Clear 2800K Frost

AE Classic Series Transformers

TRANSFORMER SPECIFICATIONS

	20W	40W	60W	100W	150W	250W	500W
120/12VAC	MT20-12	MT40-12	MT60-12	MT100-12	MT150-12	MT250-12	MT500-12
120/24VAC	MT20-24	MT40-24	MT60-24	MT100-24	MT150-24	MT250-24	MT500-24
Max Wattage*	16	32	48	80	120	200	400
12V Breaker	Auto Reset	Auto Reset	Auto Reset	Auto Reset	Auto Reset	(1) 25A Push	(2) 25A Push
24V Breaker	Auto Reset	Auto Reset	Auto Reset	Auto Reset	Auto Reset	(1) 10A Push	(1) 25A Push
Height (H)	5.60"	5.60"	6.55"	6.55"	9.80"	6.75"	8.25"
Width (W)	2.10"	2.10"	2.55"	2.55"	3.00"	4.875"	5.62"
Depth (D)	2.10"	2.10"	2.55"	2.55"	3.00"	4.62"	5.25"
Weight (lbs)	2	2	3	7	7	13	19

*These numbers reflect the 20% safety factor that is recommended to avoid overload or nuisance tripping when selecting a transformer. (Wattage x 1.20)

To calculate amperage, divide total wattage by secondary voltage (Wattage/Voltage = Amperage).
To calculate wattage, divide amperage by secondary voltage (Amperage/Voltage = Wattage)

Phantom Classic Lighting Strips - Ordering Matrix
Sample Order Number: **AE-1-4-0.6-12-27-AD-12-FW-24**

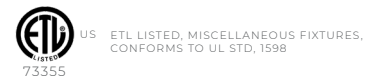

MODEL	TRIM PROFILE	LAMP SPACING	LAMP WATTAGE	OPERATING VOLTAGE	LAMP TYPE	LEAD TYPE	LEAD LENGTH	TRIM COLOR	TRIM LENGTH
AE	1	4	0.6	12	27	AD	12"	FW	24"
AE	1	4"	0.6 - LED	12	27 - 2700K LED	AD - Adjustable Leads	12"	FW - Flat White	Inches
	2	6"		24	35 - 3500K LED			GW - Gloss White	
	3	CS - Custom Spacing	3 - Xenon		50 - 5000K LED			FB - Flat Black	Specify Your Trim Length In Inches
	4		5 - Xenon		XFR - Frost Xenon			GB - Gloss Black	
			10 - Xenon		XCL - Clear Xenon			LB - Light Beige	
								MB - Medium Brown	
								LA - Light Almond	
								UF - Unfinished	
								CC - Custom Color*	

*Contact factory for details